

ケース型番 / Product Number

EXHS 141 - 51 -

色記号
Color Code

寸法制限範囲 / Dimension limit range

D = 40 ~ 500

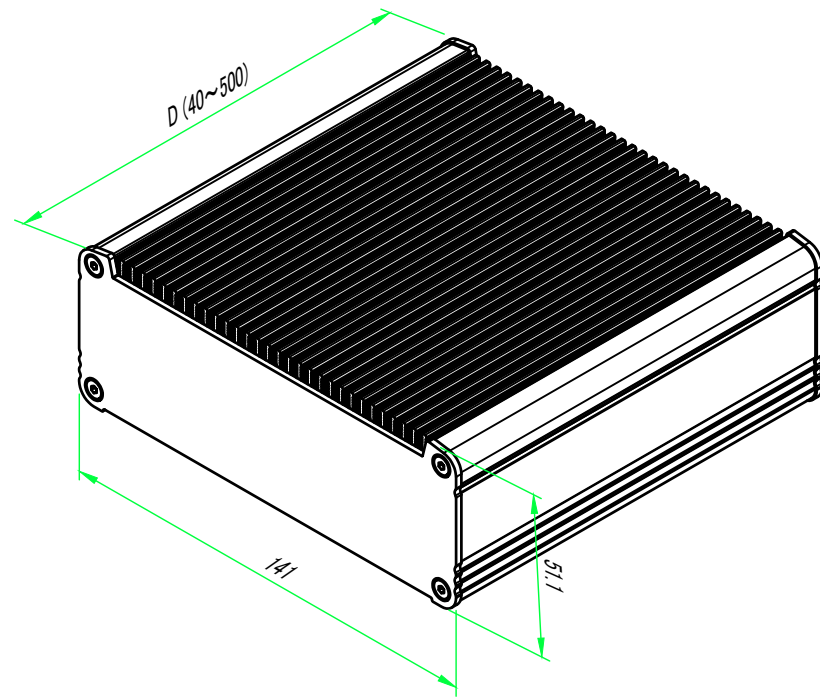

構成内容 / Components				
No.	名称 / Part name	数量 / Pcs	材質 / Material	色・表面処理 / Color・Finish
1	パネル / Panel	2	アルミ板 / Aluminium A1050P	シルバーアルマイト,ブラックアルマイト / Silver,black・Anodized
2	ヒートシカパー / Heat-sink top cover	1	アルミ押出材 / Extruded aluminium A6063S-T5	シルバーアルマイト,ブラックアルマイト / Silver,black・Anodized
3	下カバー / Bottom frame	1	アルミ押出材 / Extruded aluminium A6063S-T5	シルバーアルマイト,ブラックアルマイト / Silver,black・Anodized
4	取付ビス(M3×8皿六角穴付) / Screw	8	ステンレス / Stainless steel	無処理 / Unfinished
5	ゴム足 / Rubber feet	4	ポリウレタン / Polyurethane	ブラック / Black

※ゴム足は任意の場所に貼り付けできます。
※Adhesive rubber feet in cluded.

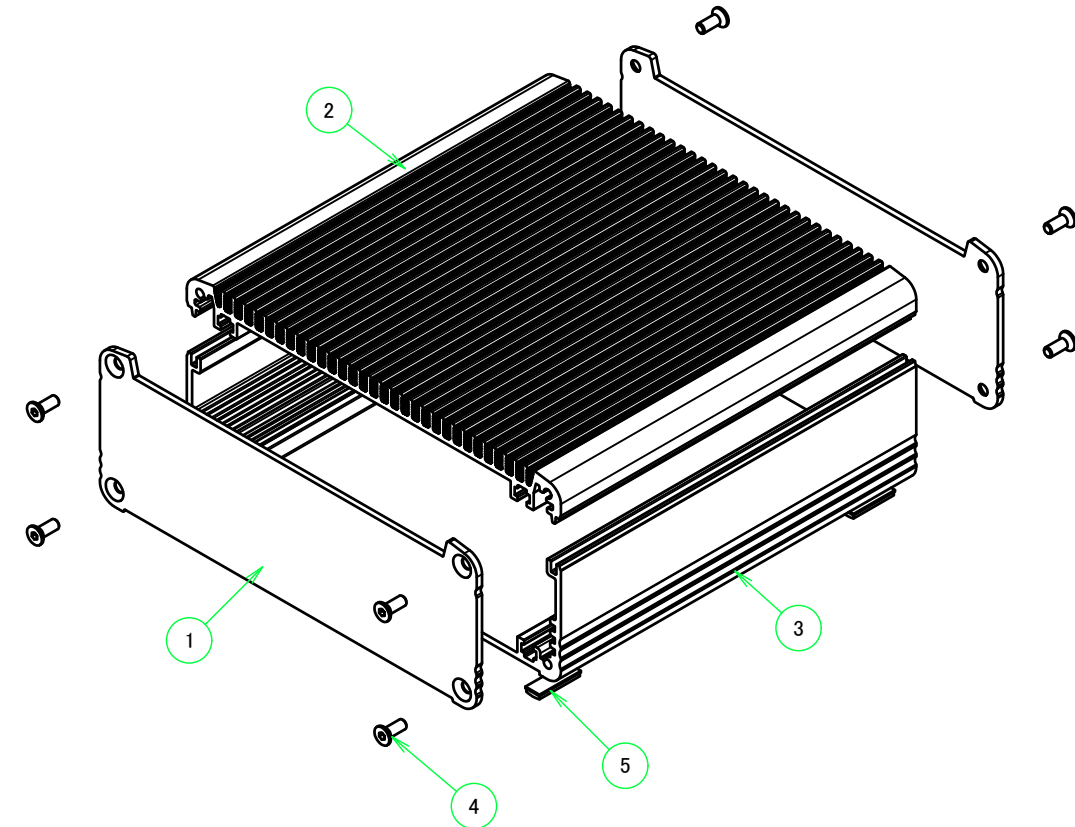

色仕様(型番末尾口)/Color type

記号/Code	上下カバー/Cover	パネル/Panel
SS	シルバー/Silver	シルバー/Silver
SB	シルバー/Silver	ブラック/Black
BS	ブラック/Black	シルバー/Silver
BB	ブラック/Black	ブラック/Black

株式会社タカチ電機工業 TAKACHI ELECTRONICS ENCLOSURE CO., LTD.			品名/Title ヒートシンクアルミフリーサイズケース HEAT-SINK ALUMINIUM ENCLOSURE -CUSTOM LENGTH-	尺度/Scale 1 : 2
承認/Approved	検図/Checked	製図/Created	型番/Product number EXHS141-51-□□□	
中根	大江	岡本	作成日/Date 2019/07/09	1 / 5

ゴム足

Rubber feet

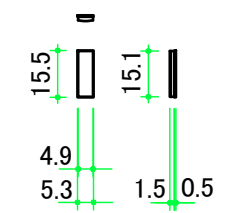

4-M3皿ビス
4-M3 Countersunk

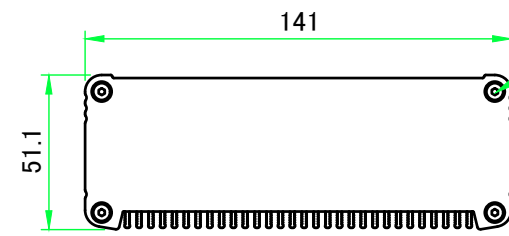

B-B (1:2.5)

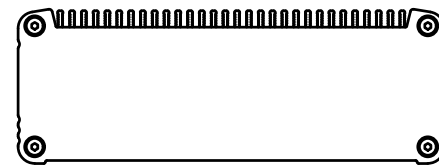
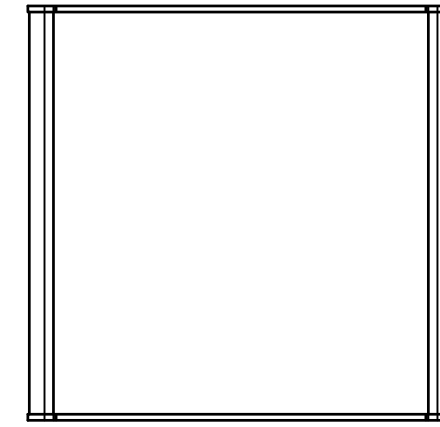
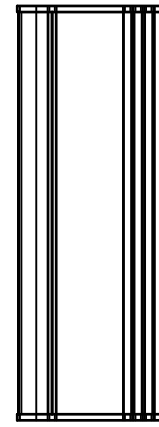
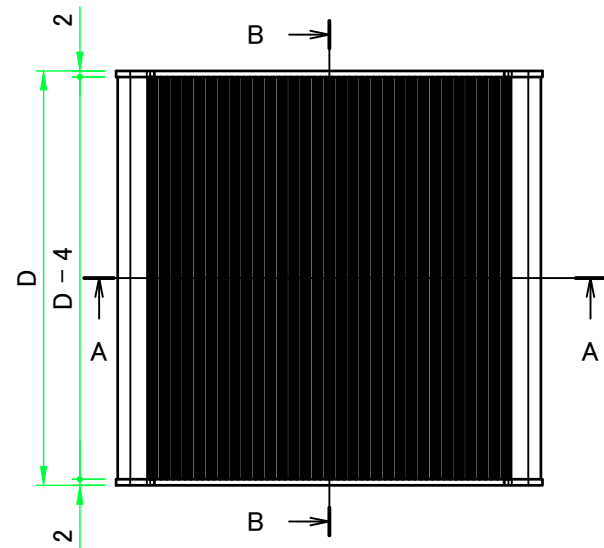
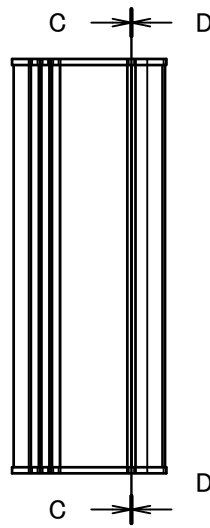
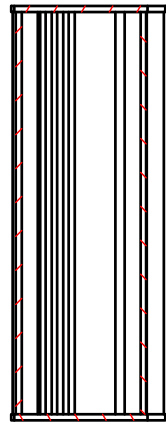

A-A (1:2.5)

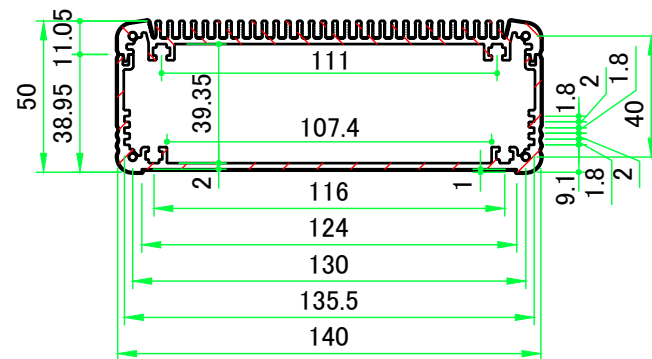

C-C (1:2.5)

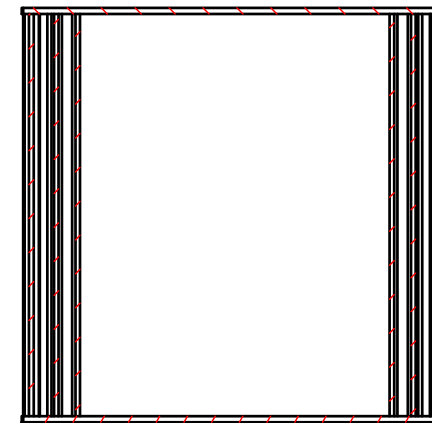

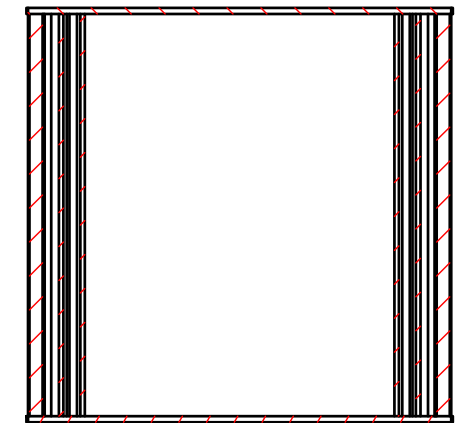

D-D (1:2.5)



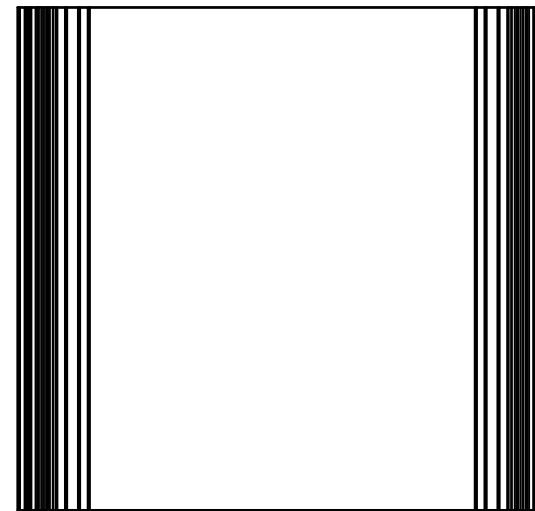
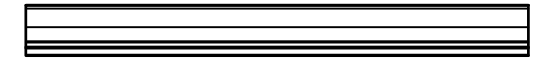
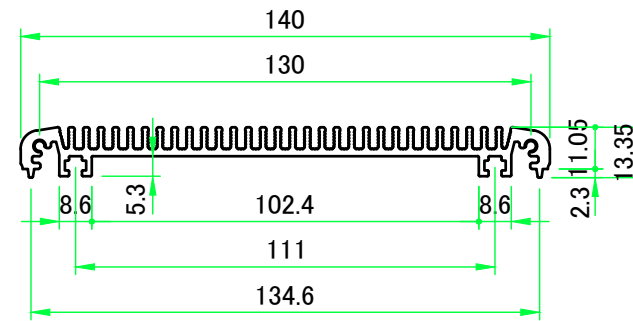
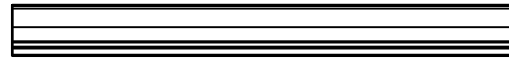
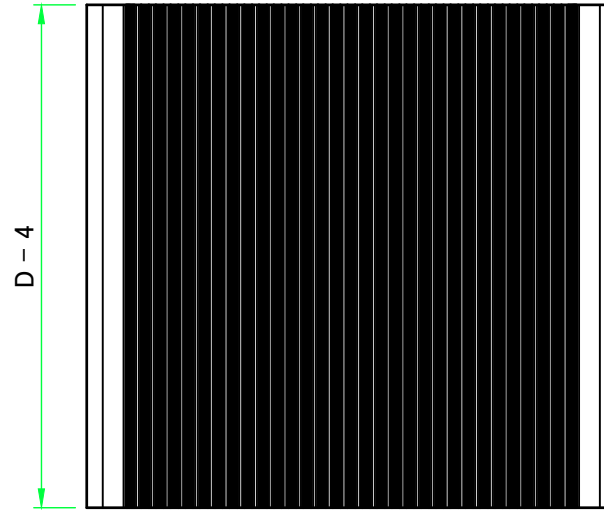

株式会社タカチ電機工業 TAKACHI ELECTRONICS ENCLOSURE CO., LTD.			品名/Title ヒートシンクアルミフリーサイズケース HEAT-SINK ALUMINIUM ENCLOSURE -CUSTOM LENGTH-	尺度/Scale 1:2.5
承認/Approved	検図/Checked	製図/Created	型番/Product number EXHS141-51-□□□	
中根	大江	岡本	作成日/Date 2019/07/09	2 / 5

ヒートシンク / Heat-sink

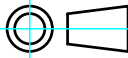

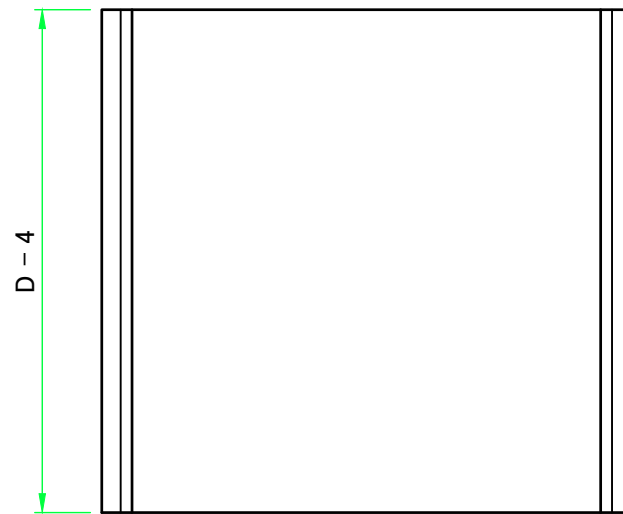
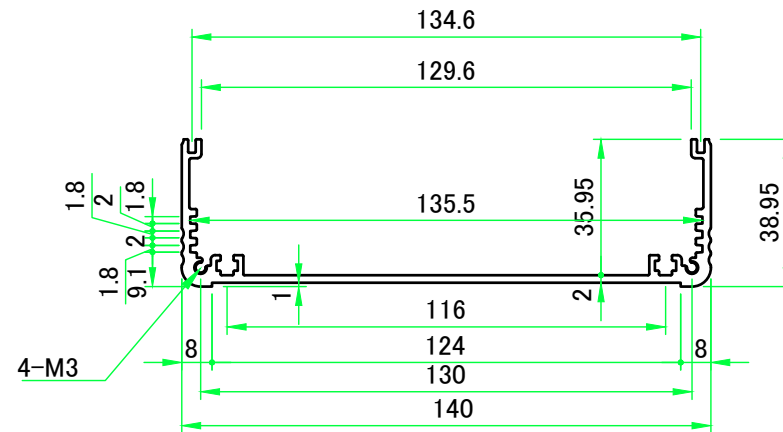
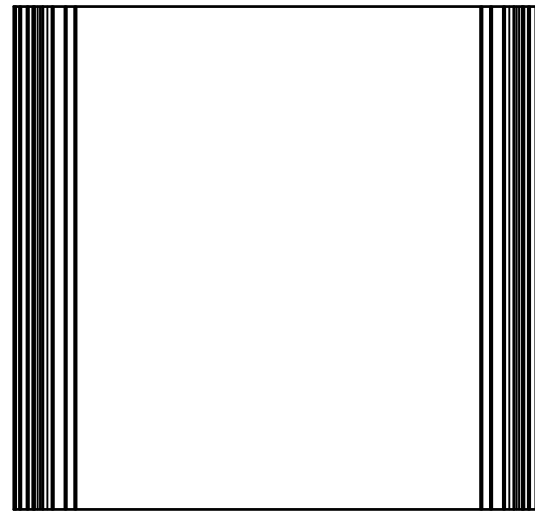
 株式会社タカチ電機工業 TAKACHI ELECTRONICS ENCLOSURE CO., LTD.			品名/Title ヒートシンク上カバー HEAT-SINK TOP COVER	 尺度/Scale 1 : 2
承認/Approved 中根	検図/Checked 大江	製図/Created 岡本	型番/Product number W140-D	
			作成日/Date 2019/07/09	3 / 5

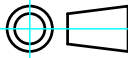

 株式会社タカチ電機工業 TAKACHI ELECTRONICS ENCLOSURE CO., LTD.			品名/Title 下カバー BOTTOM COVER	 尺度/Scale 1 : 2
承認/Approved 中根	検図/Checked 大江	製図/Created 岡本	型番/Product number W140-H50-D 作成日/Date 2019/07/09	

パネル / Panel

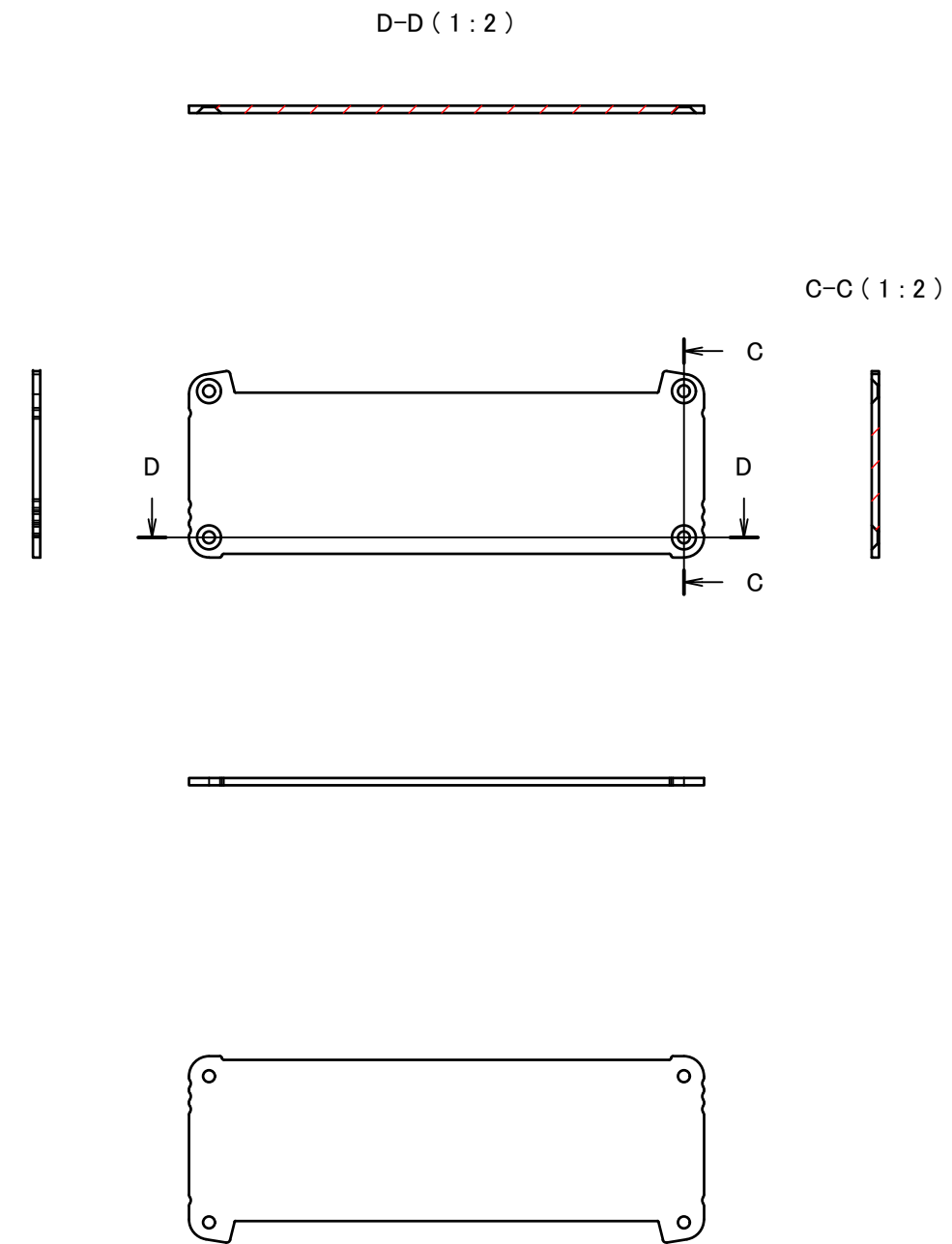
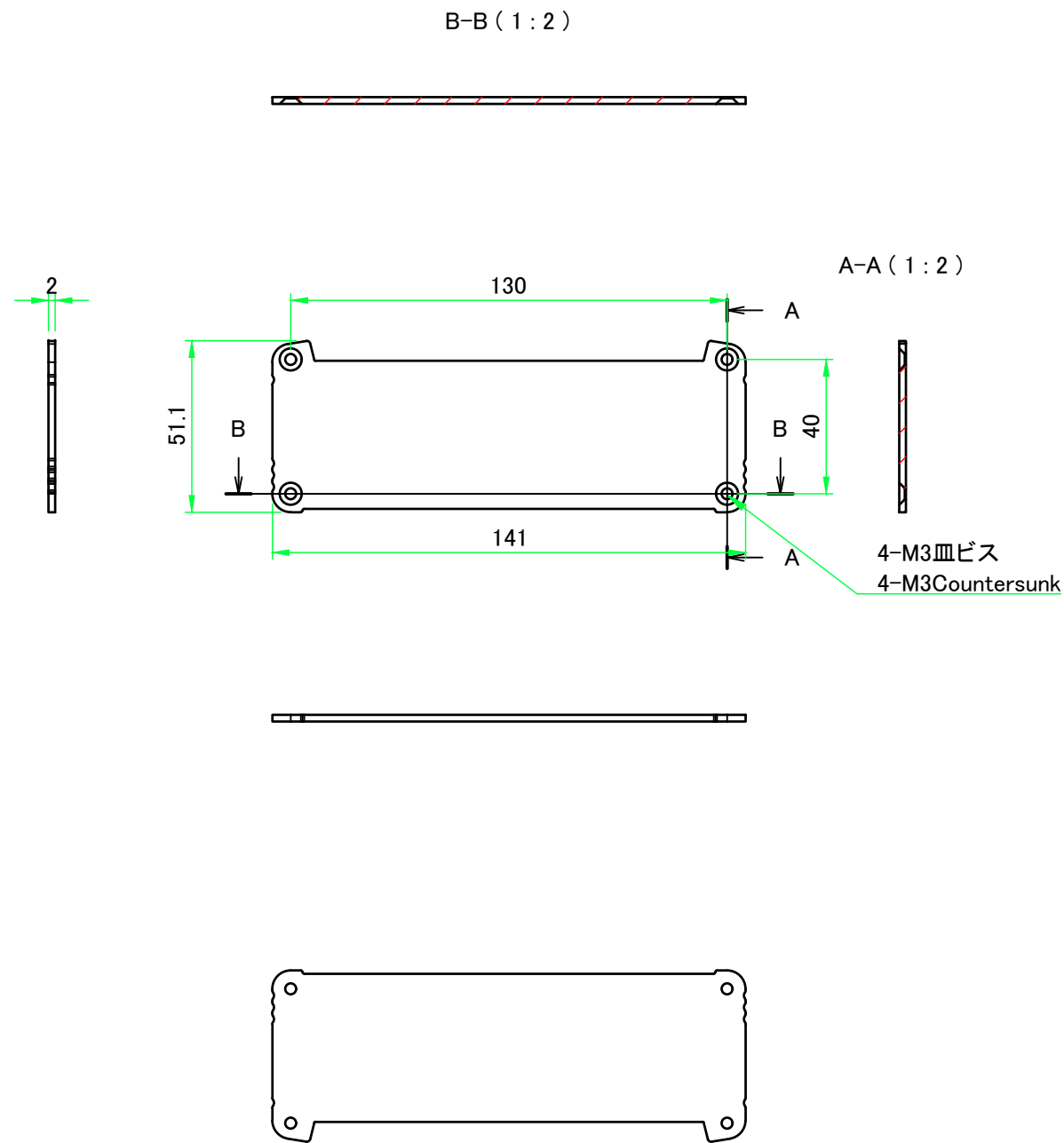

株式会社タカチ電機工業 <small>TAKACHI ELECTRONICS ENCLOSURE CO., LTD.</small>			品名/Title アルミパネル END PANEL	尺度/Scale 1:2
承認/Approved	検図/Checked	製図/Created	型番/Product number W140-H50	
中根	大江	岡本	作成日/Date 2019/07/09	5 / 5